

INDUSTRIAL Laser Solutions

FOR MANUFACTURING®

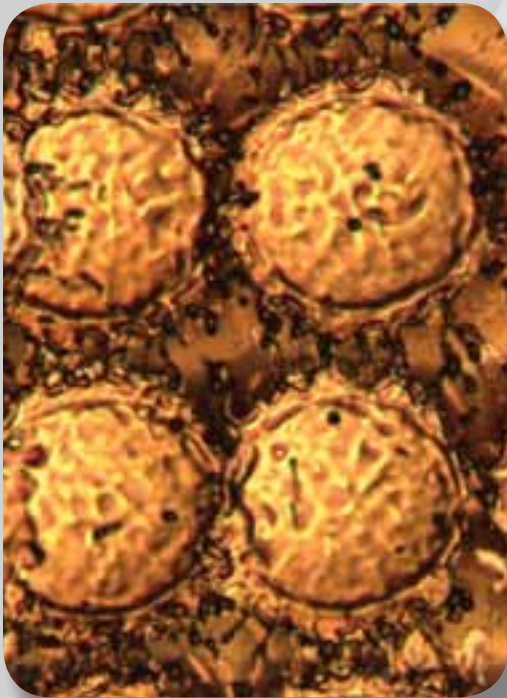

TECHNICAL DIGEST

Fiber Lasers Technical Digest

In the world of industrial laser materials processing, fiber lasers have been described as a “disruptive technology.” This may well have been true a few years ago, but over the past three years fiber laser processing in the global manufacturing sector has grown 63%, proving its technical and economic advantages integrated into processing systems. Arguably, fiber laser technology has lifted the entire industrial laser material processing industry to a swift and profitable recovery from the recent recession in global manufacturing. With a more than 20% share of an \$8 billion market, this no longer sounds like a “disruptive technology.” Several of the expanding applications for fiber laser processing are described in this Digest.

SPONSORED BY:



3 Laser Marking
with Fiber Lasers

11 Fiber Laser
Technology
Broadens Out

18 Drilling with
Fiber Lasers

25 Fiber Laser
Spot Welding



Yes, it cuts.

But you know there is a better way.

The same can be said for your existing flatbed cutter.



Systems technology is constantly changing and evolving but staying relevant and ahead of your competition doesn't mean having to spend an exorbitant amount of money. IPG's fiber lasers are affordable, compact, maintenance-free and energy efficient, saving you money upfront and minimizing overhead costs. Additionally, unlike CO₂ lasers, IPG's lasers are capable of cutting most metals, even copper, aluminum and brass, therefore broadening the capabilities of the flatbed cutter.

Do your research and see why IPG Photonics' fiber lasers are the best power source available for today's flatbed cutting systems.

Contact IPG Photonics today for a list of authorized suppliers of flatbed cutting machines.

IPG Photonics Corporation
(508) 373-1100 • sales.us@ipgphotonics.com • www.ipgphotonics.com



2 kW Ytterbium Fiber Laser, 558 x 790 x 815 mm



Laser marking with fiber lasers

Speed, simplicity, ruggedness, and cost-effectiveness give fiber lasers an advantage in this “black art”

by TONY HOULT

THE LASER MARKING industry has proliferated over the last 10 years, and laser-marking systems are now available from many suppliers worldwide. Almost every industry requires traceability for an increasing number of manufactured products and components, and laser marking has solved many of these requirements due to the inherent flexibility, speed, reliability, and ease-of-use of laser systems when compared to conventional marking techniques. Although many different laser types and several different laser wavelengths have been and are being used, fiber lasers in particular have seen a dramatic increase - almost all marking systems producers have at least one fiber laser-powered model in their range. The benefits of fiber laser technology are well known and well documented, but this article will review some additional less well-known background, and examine the benefits of fiber lasers for the particular case of laser marking.

Market review

Low-power continuous wave fiber lasers were in limited use for marking integrated circuits around 1998, and it was sometime after this that the first pulsed nanosecond units, capable of a far wider range of marking applications, were introduced - this was really the start of the fiber laser revolution, which is still gathering pace. Across all market segments global fiber laser revenues rose 48% in 2011, and in the marking and engraving segment, fiber lasers showed a 34% increase in sales as opposed to diode-pumped solid state (DPSS) lasers which grew only 4% last year.¹ The rise in the use of fiber lasers for marking has virtually eliminated flash lamp-pumped solid-state lasers at low power levels (<30 W). The last stronghold of other infrared laser types in the marking and engraving field has been at higher power levels (>30 W) for deeper, faster

engraving. The development of 50 W pulsed nanosecond fiber lasers, however, means that even this segment is now taking up fiber lasers. Illustrating the growth in use of fiber lasers at all power levels in this sector, more than 10,000 of these units were sold in 2011 by the one dominant supplier.

Background history

With the recent 50th anniversary of the laser and the recent loss of the US inventor of the fiber laser, Elias Snitzer, it is perhaps appropriate to discuss why fiber lasers are so radically different from other laser types. Both solid-state lasers and fiber lasers employ one of a number of rare earth elements as the active medium to produce laser beams. The title “rare earths” came about because at the time of their discovery they were indeed thought to be rare. Recent discoveries have shown that the ores of these elements do occur in many places worldwide, although there are some concerns over supply as much of the current reserves occur in Chinese territory in Inner Mongolia. These rare earth elements make up the upper of the two lines at the base of the periodic table of elements. These 15 elements - completely un-pronounceable and probably un-spellable to many outside the laser industry - belong to the group known as the lanthanides because of their chemical similarity to the element lanthanum. The rare earth active element in most widely used fiber lasers is ytterbium, named for the small Swedish village of Ytterby close to where large deposits of this and a number of other rare earth ores were first found.² The complex electronic structure of ytterbium allows efficient generation of coherent photons when this element is carefully distributed within the core of the laser, the active fiber (FIGURE 1).

The difference between a fiber laser and other free-space solid-state laser

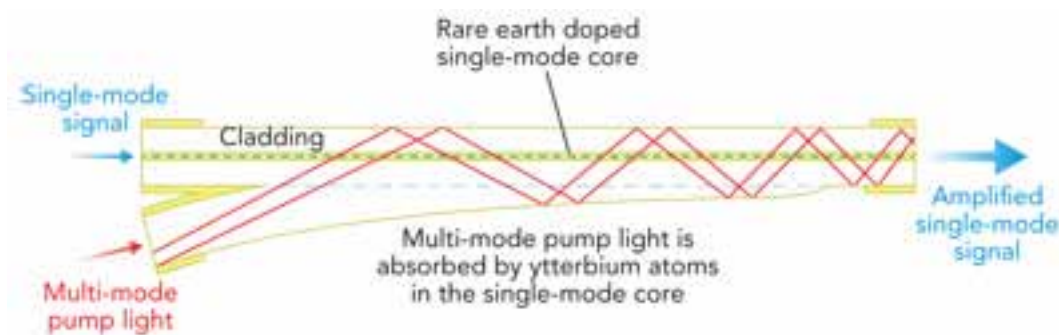

FIGURE 1. Basic construction of the active fiber in a fiber laser.

technologies are widely misunderstood and sometimes misrepresented. In a fiber laser the beam is actually generated within the fiber. In other technologies, the beam is generated in free space and is then squeezed into a fiber-optic cable to be delivered to the workpiece.

Wavelengths for laser marking

It has been well known for many years that at near-infrared wavelengths, metal reflectivity is significantly lower than at the longer emission wavelengths of carbon dioxide gas lasers at 10.6 μm . A second benefit of using shorter wavelengths is that the divergence of a laser beam is proportional to its wavelength and inversely proportional to the diameter of the beam, summarized in the equation below:

$$\Theta = \lambda/(\pi\omega)$$

where Θ = beam divergence, λ = laser wavelength, and ω = beam waist.

So, shorter wavelengths allow smaller focused spots and hence smaller surface features. Despite these focusability limitations, longer-wavelength far-infrared gas lasers still retain a strong position within the marking industry, because many widely marked materials such as paper and thin-film optically transparent polymers simply do not absorb enough of the laser beam. This absorption is required to generate localized features on the surface that are visible to the unaided human eye.

Lasers producing near-infrared wavelengths, such as fiber lasers, are used for marking a very wide range of materials, both metals and non-metals. In these

FIGURE 2. Laser-marked 304 stainless steel, 20 kHz, 0.5 mJ, 2 m/s. Melt spots are 70 μm dia.

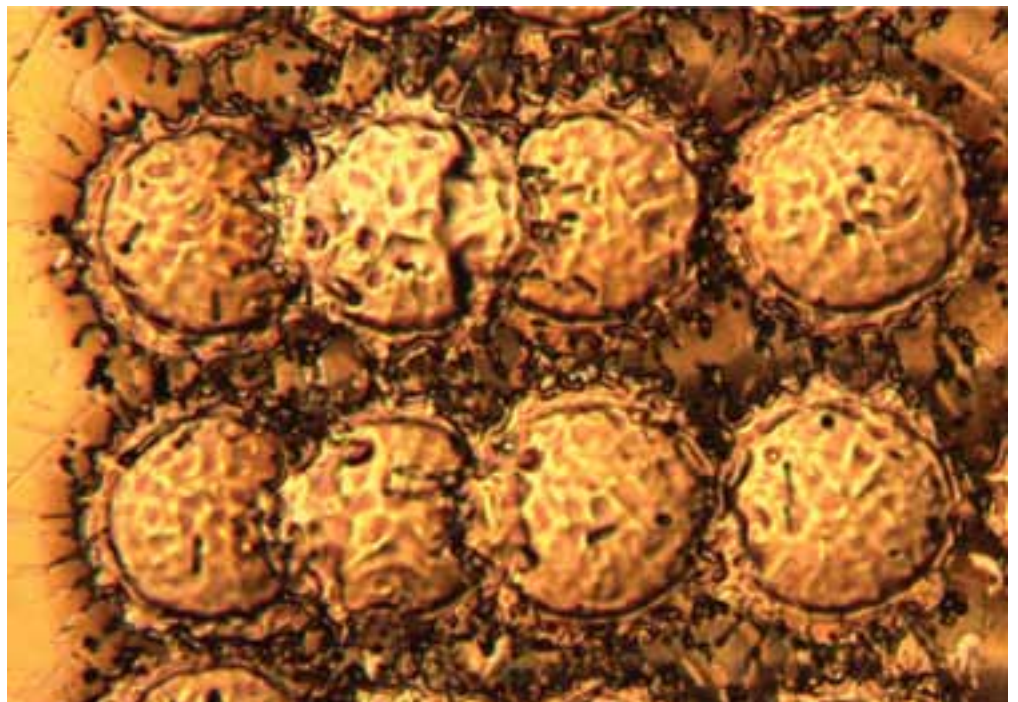

cases, marks that must be visible by the un-aided eye are created either by ablating material or by creating oxide layers on the surface, or by a combination of both of these. An ablative mark might appear very precise to the un-aided eye, but examined under higher magnification one can usually see evidence of the small-scale but very dynamic and energetic heating and vaporization processes that are occurring. Although most of these features cannot be resolved by the un-aided eye and are so shallow as to not affect the functionality of the component in most circumstances, the slightly roughened edges are probably responsible for light scattering and hence making the mark visible (FIGURE 2).

Many polymers can also be laser-marked by inducing a range of surface effects such as foaming, carbonization, and ablation. For marking lighter-colored polymers, thin polymer films, or semiconductor materials such as silicon when small features are required, even better absorption may be necessary - although the reasons for this are beyond the scope of this article, in some cases shorter wavelength lasers in the visible spectrum are used.

What can laser marking systems do?

Laser marking system manufacturers all use very sophisticated commercially available laser marking software to control the galvanometer scanners that produce relative motion between the laser spot and the workpiece. It is the laser and the optics at the heart of the machine, however, that control the marking mechanisms the system can produce. These marks can be almost infinite combinations of characters and graphics, logos, unique serialized alphanumerics, or one of a number of different barcode designs. There are many justifications for this: traceability, anti-counterfeiting, material, batch or manufacturer identification. The primary function of all marks is they must be readable, either by machine or by the unaided eye. Other secondary requirements may be:

- :: The functionality of the part must not be compromised throughout its lifetime in any way - for example, it should not mechanically weaken or cause corrosion of the part;
- :: The mark must endure for the lifetime of the part; and
- :: The mark must be aesthetically pleasing.

The sophistication of laser marking systems make the marking process look

very simple, but laser marking software allows many different approaches to producing an optimized mark on a particular surface. A range of scan speeds, scan line overlaps, scan patterns, and laser delays are available, and different operators may use very different approaches to achieve a similar mark. This tells us that laser marking is still something of a “black art” - although some general rules can be applied, a great deal of laser marking is still experientially based.

Technical benefits of fiber lasers

One major benefit of ytterbium-doped fiber lasers is that the near-infrared 1070 nm wavelength emitted is close enough to the 1064 nm wavelength of neodymium-doped Yttrium aluminum garnet (Nd:YAG) lasers as to make no difference during the actual process of laser marking. This made for a relatively easy replacement of continuous wave Nd:YAG lasers by fiber lasers for most marking applications. This early success exposed the marking industry to fiber lasers and their many additional benefits became better understood. This led, in turn, to more advanced applications where fiber lasers were able to challenge the still relatively new diode-pumped solid-state laser technology.

FREQUENCY (KHZ)	PULSES/HOLE	DRILL TIME (MS)	AVERAGE HOLE VOLUME (MM ³)	REMOVAL RATE (MM ³ /S)	REMOVAL EFFICIENCY (MM ³ /J)	REMOVAL RATE (MM ³ /MIN)
50	250	5	0.029	6.37	0.12	382.4
100	2000	40	0.034	0.86	0.03	51.8

Ablation rates using 50 W nanosecond fiber laser for percussion drilling 0.6 mm thick 304 stainless steel.

Another often unappreciated aspect of fiber lasers is that the whole optical path of the laser is fully maintained and hermetically sealed within zero-loss fully coated optical fibers - it must be made this way when the optical fibers are produced. The continuous optical path is achieved by combining all of the fiber-based optical components using advanced optical fiber splicing techniques. This approach has enormous benefits and is unlike any other laser technology, in that no optical misalignment is possible until the laser beam exits into the focusing optics. Another related aspect is that in principle it is very simple to generate higher average power; one simply uses longer active fibers or additional fiber amplifier stages with more pump diodes. Of course, this scaling simply cannot be achieved without an in-depth understanding of the science and technology of fiber lasers, which in turn leads to an understanding of precisely where damaging optical effects such as Raman scattering will occur and can be avoided.

Fixed or variable pulse length nanosecond fiber lasers

Both fixed and variable pulse length nanosecond lasers have been used extensively for laser marking, and the simplicity, ruggedness, and cost-effectiveness of fixed pulse length fiber lasers has, as we have seen, allowed significant market penetration. There are, however, a limited number of circumstances where the added flexibility of a shorter laser pulse can provide benefits. One good example of this in the field of laser marking is marking clear polycarbonate components. The mechanism is rather different from most other materials in that small micron-sized bubbles are generated beneath the surface of the material and these bubbles appear black to the unaided eye. Reducing the pulse length to 30 ns along with careful control of other marking parameters such as speed, pulse energy, and the distance between fill lines allows these bubbles to be generated beneath the surface without agglomerating into features that disrupt the surface of the component (FIGURE 3).

This approach is highly desirable for marking medical devices as unwanted debris entrapment can be eliminated. There are benefits for some highly specialized marking processes in using even shorter pulses,

as low as 1.5 ns. Once again, fiber lasers have a significant advantage because these short pulses and high pulse repetition rates can be achieved without compromising average power to any great extent. For example, one particular model available from the leading supplier delivers 18 W average power at 300 kHz with 1.5 ns pulses (60 μ J), an M2 of 1.3, and a peak power >40 kW. Although pulse duration is an important laser processing variable, it is only one of a number of



FIGURE 3. Subsurface mark in polycarbonate. Letters are 2 mm tall.

factors that contribute to producing a particular feature size. This parameter combination allows off-the-shelf infrared fiber lasers to produce feature sizes with conventional optics that have only previously been obtainable using more complex and costly shorter wavelength diode-pumped solid-state lasers.

What does higher average power do for laser marking?

Because of the complex nature of the phenomena involved in laser marking, it is difficult to predict whether marking speed or marking depth will double by doubling the power of the laser. In most cases, however, a higher average power laser will allow users to mark either faster or deeper, or a combination of both. For applications where a significant depth to the mark is required, 30 W or even 50 W lasers have been developed without any increase in footprint and without any compromise in the focusability (or brightness) of the laser. The results shown in the table above were gathered during percussion drilling experiments with a 50 W fiber laser. Although this is the best possible case for material removal (the mechanism that is observed when deep engraving metals), removal rates as high as 5 mm³/s have been measured. It should be noted that using a higher average power laser translates directly into a higher heat input to the part, and distortion on thinner components may well limit the average power that can be used. When mark depth is >100 μm, these marks retain their readability even after serious abuse of metal surfaces; this may be deemed “tamper evident” in that a significant amount of adjacent material needs to be removed to render the mark illegible.

Mid infrared-wavelength fiber lasers

There are a number of other rare earth elements from the same Lanthanides group in which ytterbium resides that have been used as active media in solid-state lasers to generate alternative wavelengths. Holmium (Ho), erbium (Er) and thulium (Tm) are all adjacent to each other in the periodic table, and all of these have been used for some years in fiber lasers for various non-industrial laser applications such as laser surgery, largely due to the high absorption of this wavelength by H₂O. Thulium fiber lasers emitting longer wavelength beams (in the spectral region of 1900-2010 nm) have now been developed to very high power levels (>100 W) for melting processes such as polymer welding due to their higher volumetric absorption in unfilled polymers. These lasers are not yet available at power levels in the pulsed nanosecond regime to be of interest to the laser marking industry, but they will be available in the not-too-distant future.

Summary

It is quite a technological leap from using fiber optic cables to simply guide near-infrared laser beams, to both generating and guiding the beam using all fiber optics - but the benefits of combining these functions are now obvious for all to see. As one well-known manufacturer of laser marking systems told me recently: “The reason we love these lasers is simple; we take them out of the box, we plug them in, we test the system, we ship it straight out of the door, and we never see them again.” What more can be said!

References:

1. David A Belforte, “2011 Annual Economic Review and Forecast”, *Industrial Laser Solutions*, January 2012.
2. Sam Kean, “ The Disappearing Spoon”, Back Bay Books, ISBN 978-0-316-05164-7.

.....

DR. TONY HOULT (thoult@ipgphotonics.com) is the general manager of West Coast operations for IPG Photonics, Santa Clara, CA. He is also an Editorial Advisor to *Industrial Laser Solutions* and a frequent and valued contributor to this publication.

Fiber laser technology broadens out

Mid-infrared laser wavelengths open up new processes

by TONY HOULT

THE TELECOM CRASH in the late 1990s can be seen in hindsight as a pivotal event in the history of industrial lasers; from it emerged industrial fiber laser technology. The existence at that time of in-depth scientific and engineering expertise in active fibers and fiber amplifiers, combined with the availability of an extensive toolkit of components, enabled a brisk scaling-up of laser power into the multi-kilowatt regime.

The industry's shift to fiber laser technology is now challenging well-established lasers in many sectors of the industry. CO₂ and Nd:YAG laser technologies are now almost 50 years old, but the huge success of this new technology comes as no surprise to those who have worked with both the old and the new. The major impacts have been in multi-kilowatt metal processing and in low-power general-purpose laser marking, but there is also rapid progress in other areas. The following presents the emergence of a new process for a new class of mid infrared longer wavelength fiber lasers.

While the differences between a CO₂ gas laser and a fiber laser are obvious and these two technologies cannot be confused, the difference between a fiber laser and a fiber-delivered laser is not always immediately apparent. The technology change comes from generating the beam within the fiber itself, and the inclusion of other optical fiber components within the same continuous hermetically sealed fiber-optic beam path. This contrasts with fiber-delivered lasers, where the beam is generated by an array of solid-state optical crystals and discrete optical components and is delivered to the workpiece via fiber for only the final part of its journey. The fiber laser is produced by constructing continuous beam paths

within fibers; these are very familiar techniques for those in the fiber optics industry. This fit-and-forget process is at the heart of the success of the fiber laser, as it removes the need for maintenance issues associated with other types of industrial lasers.

Fiber lasers in the mid infrared

The infrared portion of the electromagnetic spectrum is usually divided into three regions; the near-, mid-, and far-infrared (FIGURE 1).¹

Our concern here is with the higher-energy near-IR regime, approximately 0.8–2.5 μm wavelength. Laser scientists are familiar with CO_2 lasers where electromagnetic bonds between atoms are seen as quantum mechanical springs — for example, the asymmetric vibrational state of the CO_2 molecule is close to the stretching state of the N_2 molecule, so energy exchange between the two molecules occurs and lasing in the far IR occurs.

Mid-IR wavelengths are part of the fiber laser story, and thulium was seen very early on as a candidate rare-earth ion dopant for fiber lasers, because the many Tm^{3+} transitions allow a wide range of useful wavelengths to be generated using silica-based fibers in the 2 μm spectral region. Strong absorbance by water occurring around this wavelength led to an early interest in thulium fiber lasers for superficial tissue ablation with minimum coagulation depth, a form of “bloodless surgery.” Many other non-materials-processing applications have led to the availability of a range of optics for these wavelengths.

It has been known from previous work² and from spectroscopic data that many polymer matrices absorb more efficiently at this wavelength, but the reason why

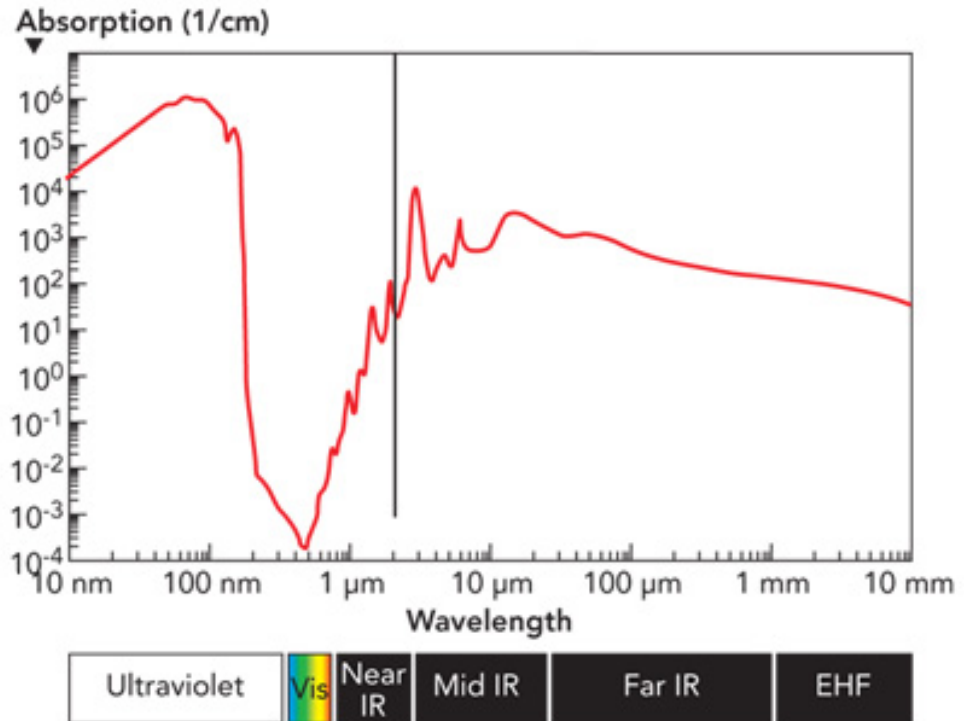

FIGURE 1. IR wavelength ranges and water absorption peak vs. wavelength.¹

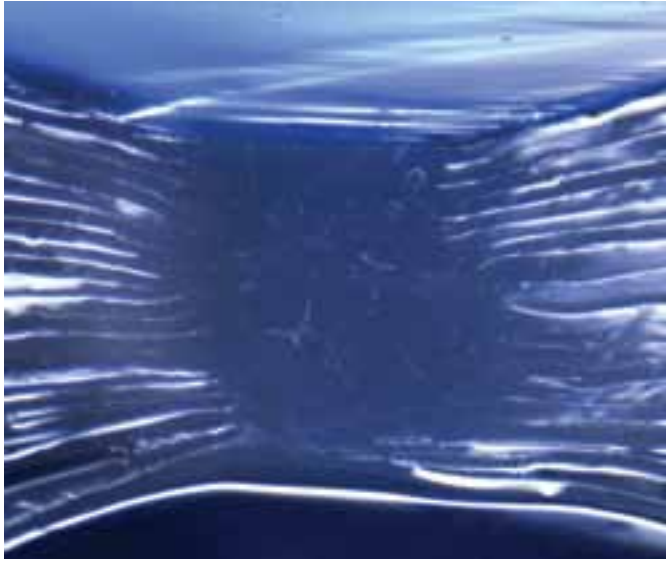

FIGURE 2. Outline of weld volume, 22 layers of 0.1 mm thick virgin LDPE.

is not immediately clear. In this mid-IR range, the spectra from even the simplest polymer materials are complicated by numerous vibrational modes and are not simple symmetrical peaks. The wavelength equivalent for a C-H bond absorption peak is typically 3225 nm, well away from the range of the thulium laser. The energy transitions in the stretch vibrational states of these C-H molecular bonds in high-density polyethylene (HDPE), for example, are therefore

TABLE 1. Absorption of Makrolon polycarbonate at 1940 nm.

THICKNESS (MM)	0.5	0.8	1.4	2.0	2.5	5.7
% LOSS	10	14	18	18	25	44

small compared to the binding energy of electrons in a carbon atom. It appears, however, that the prominent absorption closest to 1940 nm is the first overtone of the prominent fundamental C-H stretching absorption at 1724 nm. Having said that, mid-IR developments are underway and 3225 nm laser wavelengths are now becoming available. This will be an interesting area for future work.

With the availability of much higher average power at these wavelengths and the high water absorption, please ensure relevant safety standards are followed for guidance. Even the phrase ‘less unsafe’ perhaps should not be used!

Thulium fiber lasers for polymer welding

Although 50 W average power thulium fiber lasers have been commercially available for several years, recent developments have pushed average power to >100 W while still maintaining a high-brightness single-mode beam, with a power level and \$/W cost appropriate for high-volume manufacturing processes. The existing through-transmission laser welding (TTLW) technique gaining acceptance within industry only allows lap joints with one absorbing and one

transmitting component to be welded. Also, as it employs a near-IR laser, it is unable to weld clear-to-clear polymers unless an additive is used, such as Clearweld infrared dye, and this can make the laser process unacceptable.

Preliminary trials

Trials were conducted to confirm the improved absorption levels of a 1940 nm thulium fiber laser beam on many thermoplastics; results on polycarbonate (PC) are reported below. Using a 4.2 mm diameter collimated beam, power was maintained below 5 W to ensure no significant heating or melting.

This data shows that 10%–45% absorption occurs volumetrically in this clear sheet material depending on sample thickness. These results can be compared with those from a commercially available transmission tester that uses a 0.8 mW diode laser source at 850 nm, which showed >92% transmission on all samples.

As heat input to the sample is increased incrementally and by exercising careful control over the temporal and spatial characteristics of the beam, melting occurs in a highly controllable manner in materials up to 6 mm thick. A simple lap joint with very basic clamping was all that was then required to produce optically clear spot welds between two faying surfaces of like thermoplastics. Relative motion between the laser beam and the melt zone produced linear welds, controlling relative speed and power (line energy) penetration in a manner analogous to welding of metals.

The cross section of the multi-layer joint in low-density polyethylene (LDPE, FIGURE 2) was prepared as a simple way

FIGURE 3. Material failure surface at interface of 3 mm diameter PC spot weld.

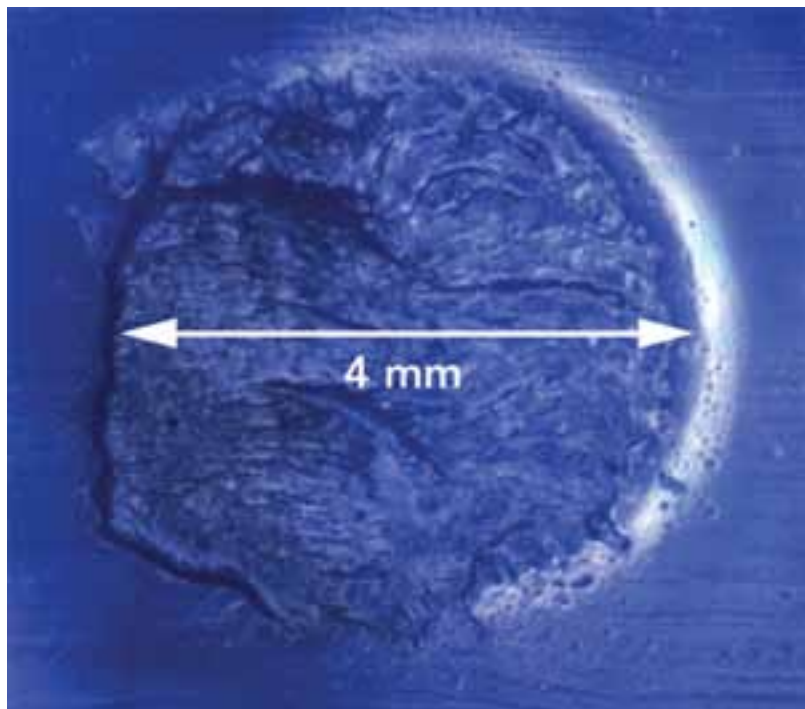

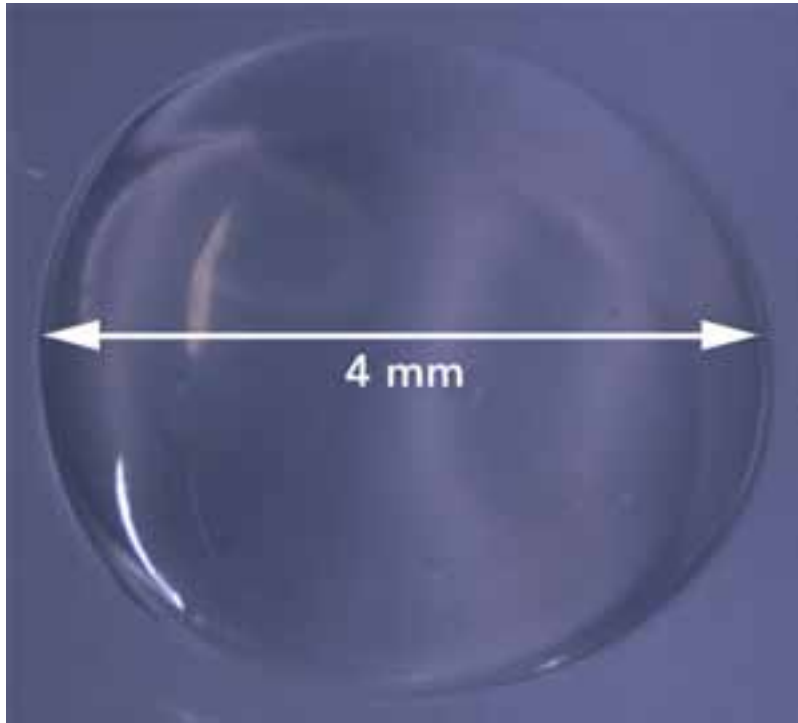

FIGURE 4. 4 mm diameter optically clear spot weld through 2 mm thick unmodified polypropylene.

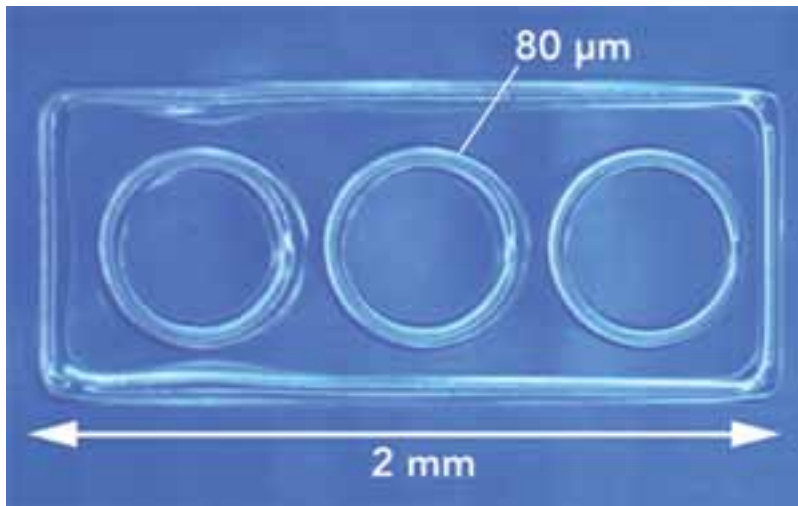

FIGURE 5. < 0.1 mm weld lines in Zeonor cyclic olefin polymer, 2 mm long simulated microfluidic device.

of delineating the melt zone. In polymers this is more difficult than for metals, where conventional metallography can be employed. As with all welds, strength depends largely on the weld area at the interface, and mechanical testing has shown that joint strengths greater than the strength of the parent material can be readily produced. FIGURE 3 shows a spot weld fracture surface in polycarbonate where cohesive material failure has occurred.

Discussion

FIGURE 2 clearly shows the volumetric absorption of the laser beam in multiple thicknesses of LDPE, which serves two purposes: it shows layers of polyethylene joined together by a high-quality weld, and clearly outlines the melt zone confirming

volumetric absorption, as expected from a consideration of Beer's Law. The classic derivation of this law divides the absorbing sample into thin slices perpendicular to the beam, and tells us that light from each subsequent slice is slightly less intense. For a parallel beam of a specific wavelength of monochromatic radiation passing through a homogeneous solid material, the loss of radiant intensity (ΔI)

is proportional to the product of the path length through the material Δx and the initial radiant intensity:³

$$\Delta I = It\Delta x$$

where t is the absorption coefficient and represents the relative loss of radiant intensity per unit path length in the material.

An important contrast exists with 4 μm : the longer-wavelength far-infrared regime is where almost 100% absorption occurs, and the polymer welding process is limited to thin films due to the relatively slow conduction processes involved.

With fine-tuning of the welding process, spot or seam welds with no visible charring or degradation were readily achieved. This simple welding technique has since been applied successfully to a wide range of thicknesses of many polymer materials (FIGURES 4 and 5). For materials ranging from 0.1–3.0 mm thickness, this absorption appears well-suited at this wavelength for welding many optically clear thermoplastics. The use of high-brightness fiber lasers allows long focal length low f-number lenses or even collimated beams to be employed, as large spots and low power density (typically $< 500 \text{ W/cm}^2$) only are required for polymer welding. As many thermoplastic polymers are well-known for their tendency to distort when welding, this enlarges the operating envelope of the process considerably, and removes the need to focus on a particular plane at the joint interface as has been necessary when lower-brightness lasers are used, so access for tooling is also much improved. Although the Gaussian nature of a single-mode beam may at first glance be considered detrimental, optical techniques for producing top-hat beam shapes are now available for this wavelength⁴ and may in some circumstances be required. Optically transmissive clamping devices can be used to produce smooth weld surfaces on rigid polymers.

There are many benefits to this process:

- :: Butt and lap joints are possible
- :: Light clamping pressure only is required
- :: Transmissive clamping plate is not always required
- :: No extra absorbers are required

- :: Optically clear defect-free welds are readily obtained
- :: Low-heat-input, sub-0.1 mm wide weld features are achieved
- :: Long focal length lenses or collimated beams rule out access issues.

What may turn out to be most important of all is that this new laser wavelength allows a far greater temporal and spatial control of heat input into polymers than has previously been possible — this may well have some very interesting consequences!

Summary

Fiber laser technology has broadened out into many sectors of the laser materials processing industry. Multi-kilowatt fiber lasers compete with other laser technologies, fiber laser powered marking systems now dominate general purpose marking, new quasi-continuous wave (QCW) fiber lasers replace flash lamp-pumped solid state lasers, low-nanosecond pulsed lasers are now established and sub-nanosecond lasers are under development, and fiber laser components already are widely employed in the pico and femto-second regime. With mid-infrared laser wavelengths opening up new processes such as that reported here, this trend looks set to continue apace.

References

1. en.wikipedia.org/wiki/Electromagnetic_absorption_by_water
2. Boglea A, Rosner A, Olowinsky A. “New perspectives for the absorber free laser welding of thermoplastics,” Proc. ICALEO 2010, Anaheim, CA, USA
3. www.lepla.org/en/modules/Activities/m17/m17-theo.htm
4. Laskin A, “Beam shaping? Easy!” Industrial Laser Solutions, July 2006, p17- 19

.....

DR. TONY HOULT (thoult@ipgphotonics.com) is general manager of West Coast operations at IPG Photonics, Santa Clara, CA.

Drilling with fiber lasers

Pulse fiber lasers lessen acquisition and operating costs

by **JENS DIETRICH** and **INGOMAR KELBASSA**

COMPANIES THAT USE laser sources for drilling have three requirements: cost efficiency, high productivity, and high quality. Cost efficiency is affected by productivity and quality, but is also determined by the operating and maintenance costs of the laser source. Quality is the compliance with specifications such as geometrical tolerances or metallurgical results, e.g., recast layer thickness. Productivity is the number of holes that are drilled per time.

The type of laser source used for drilling is not important as long as all three main objectives are achieved. Therefore, companies will use new laser sources if they have benefits in cost efficiency, productivity, or quality compared to state-of-the-art flashlamp-pumped Nd:YAG lasers.

New diode-pumped lasers such as fiber lasers seem to have benefits considering their specifications; costs of the laser sources with a mean power of less than 1 kW, and operating costs are smaller.

Smaller operating costs also result from a higher electrical efficiency, a greater lifetime of diodes compared to flashlamps, and the omission of adjustment.

When using a flashlamp-pumped laser source, the beam is guided by mirrors that need to be adjusted and have a small loss of power (0.2 to 5% per mirror). Using a fiber laser, the beam delivery system does not need to be adjusted as the beam is guided by a flexible fiber. The loss of power of the beam delivery system is rather small as no mirrors are used. Fibers as a beam delivery system are more flexible as the beam can be delivered to different work stations by beam switches or fiber replugging.

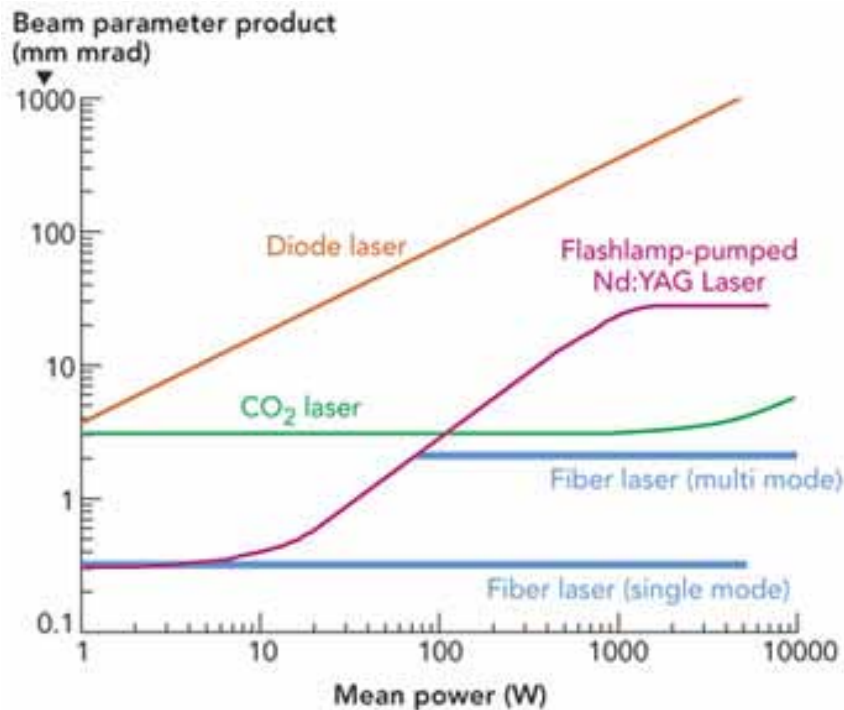

FIGURE 1. A beam parameter product as a function of the mean power of different laser sources¹.

Fiber lasers can provide a smaller beam parameter product at high mean powers compared to flashlamp-pumped Nd:YAG lasers (FIGURE 1) as fiber lasers have a smaller beam parameter product in the range above 100 W. Below 100 W, single mode fiber lasers have a comparable beam parameter product of ~0.35.

Thus, drilling with fiber lasers is applicable when quality and productivity is comparable to flashlamp-pumped Nd:YAG lasers as fiber lasers offer more cost-savings.

Editor's Note: In this article, the authors refer to the fiber laser as a diode-pumped laser.

Experimental setup

The suitability of the two different laser types for drilling – flashlamp and diode-pumped laser – is analyzed by comparing drilling results. Therefore, geometrical specifications of holes to be drilled are defined. The geometry is based on typical venting holes that are drilled in tool forms. The exit diameters of through holes are supposed to be 120 μm with a depth of 5 mm in stainless steel 1.4301. In some cases, tool forms can have several thousands of holes. Therefore, high productivity is needed to reduce manufacturing time. The hole quality, such as recast layer thickness or taper, is not specified but is considered to be as high as possible.

In the experiments, a flashlamp-pumped Nd:YAG laser LASAG FLS 652N and a pulsed fiber laser IPG YLS-600/6000-QCW with a 50 μm fiber are used. The focal length of both optics is 100 mm. With these drilling optics, the focal

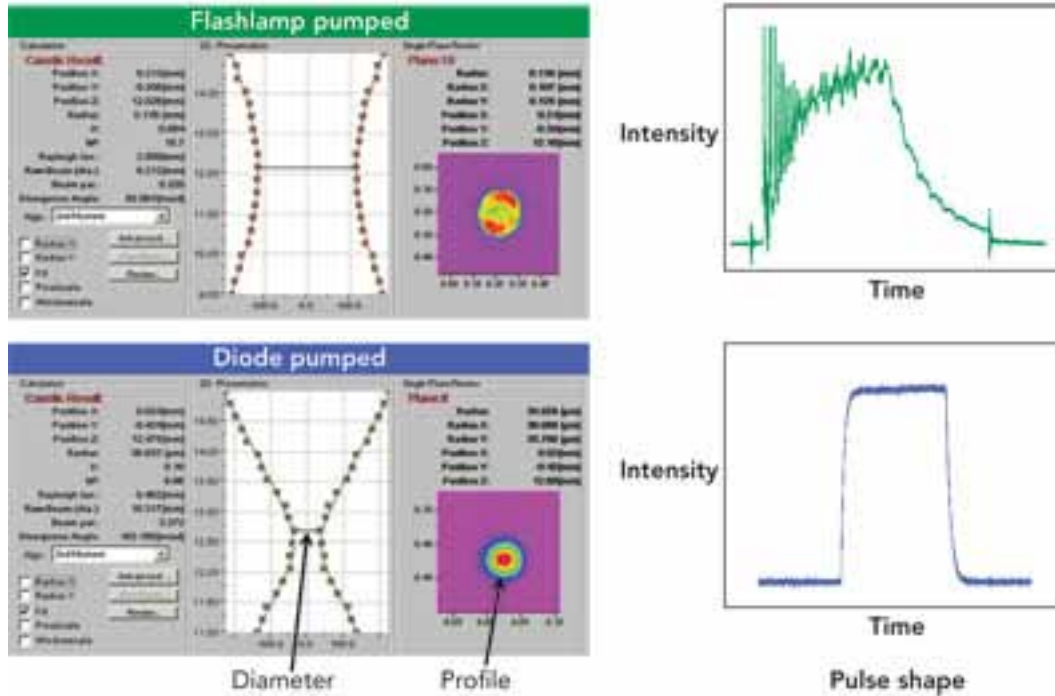

FIGURE 2. Beam profile of the flashlamp (top) and diode-pumped (bottom) laser radiation.

diameter of the Nd:YAG laser is 232 μm , while that of the fiber laser is 74 μm (FIGURE 2). The times-diffraction-limit-factor M^2 is 15.7 for the Nd:YAG and 10 for the fiber laser. The reason for choosing a flashlamp-pumped laser source with a high average power and a small beam quality is the demand for high productivity.

Oxygen with a pressure of 8 bar is used as the process gas. The distance from the nozzle to the workpiece is 1 mm. The laser beam is focused onto the surface of the workpiece. As drilling completes, the productivity, hole exit diameters, and recast layers are measured and compared.

Results

The specified hole geometry can be achieved by drilling with more than one set of parameters. Every set of parameters can have advantages such as higher productivity, but can also have disadvantages such as higher tolerances of the exit diameter or higher taper. When choosing one set of parameters, a compromise between productivity and quality has to be made. For example, choosing a higher repetition rate leads to higher productivity, but also leads to a higher taper when drilling with the flashlamp-pumped laser source (FIGURE 3). The repetition

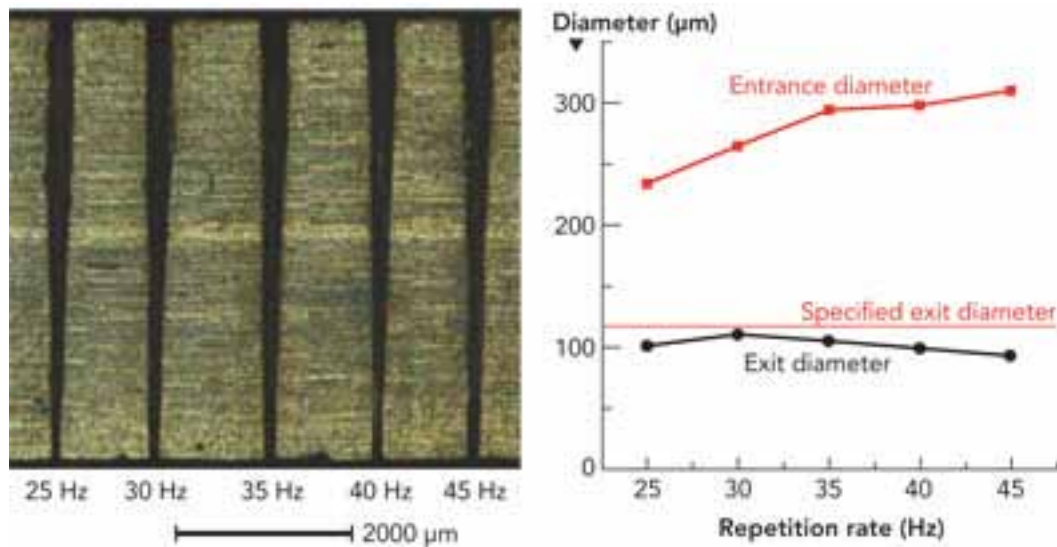
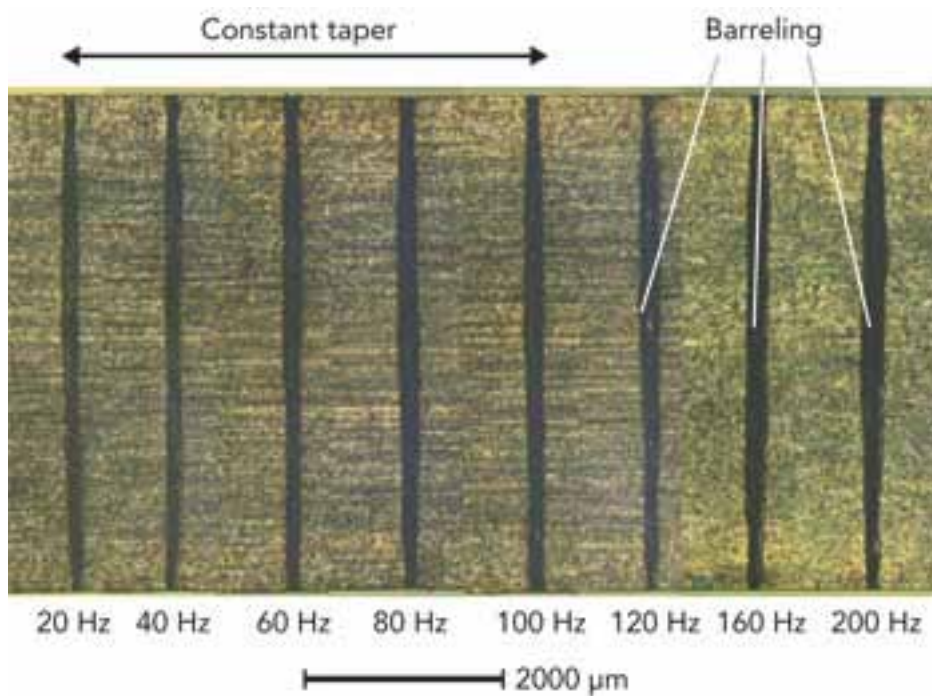

FIGURE 3. Longitudinal sections of holes drilled with the flashlamp-pumped laser varying the repetition rate (left) and entrance and exit diameters as a function of the repetition rate (right).

rate of the flashlamp-pumped laser source is fixed to 40 Hz as the entrance diameter of the hole becomes very large at higher repetition rates.

In the case of drilling with the diode-pumped laser source, the influence of the repetition rate on taper is small (FIGURE 4). When drilling with a repetition rate



higher than 100 Hz, the taper is almost constant, but the holes are enlarged in the middle (barreling). The standard deviation of hole diameters also

FIGURE 4. Hole geometries as a function of the repetition rate using the diode-pumped laser.

increases at repetition rates higher than 100 Hz. Thus, the repetition rate when drilling with the fiber laser is fixed to 100 Hz. Both repetition rates are maximized in order to have a high productivity with a reasonable geometric quality such as taper.

The parameters are set up by a systematic variation considering drilling productivity and quality. To compare the productivity of holes drilled by the Nd:YAG and fiber laser, the hole depth is measured after a defined number of laser pulses in longitudinal sections (FIGURE 5).

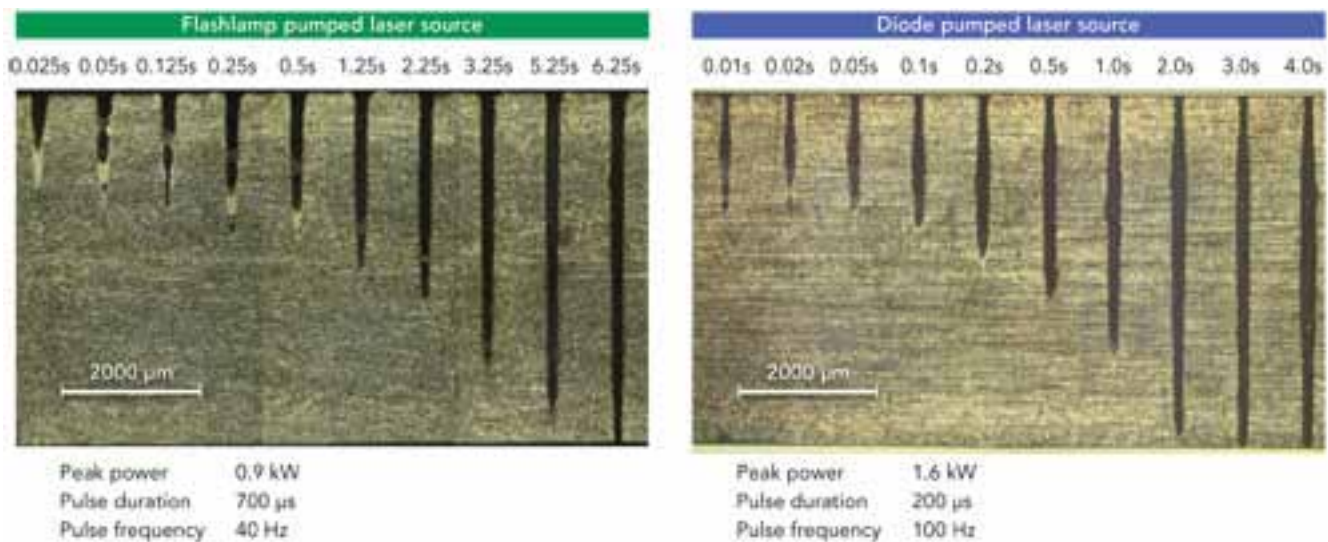

FIGURE 5. Longitudinal section of holes drilled with the flashlamp-pumped (left) and diode-pumped (right) laser source with increasing pulse count.

The drilling depth is plotted as a function of the pulse number, which is converted into time (FIGURE 6). The drill through time of the 5 mm work piece is 3 s using the diode-pumped and 6.25 s using the flashlamp-pumped laser source. The difference in the drill through time is a result of the two repetition rates.

To analyze the reproducibility of the exit diameter, several hole exits are measured. The number of holes are plotted as a function of the tolerance of the hole exit and a Gauss distribution is calculated (FIGURE 7).

The Gauss distribution of hole exits using the diode-pumped is smaller compared to the flashlamp-pumped laser source. This can be a result of the intensity profile as the times-diffraction-limit-factor of the fiber laser is smaller by a factor of 1.6.

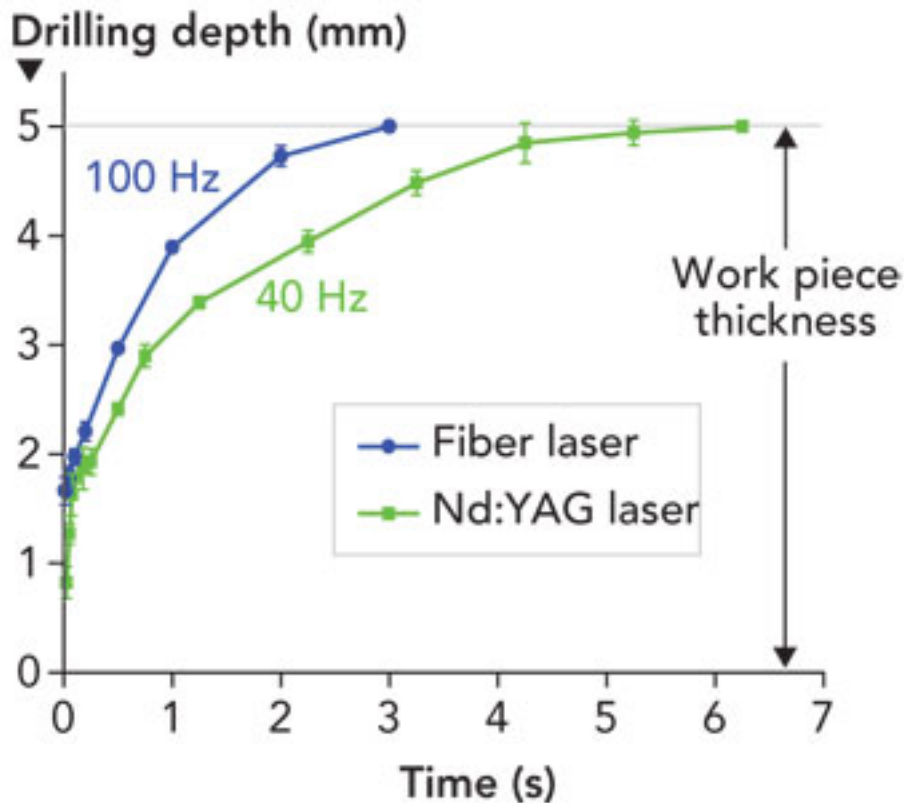

FIGURE 6. Hole depth as a function of time using the Nd:YAG flashlamp and diode-pumped fiber laser.

Also, the pulse-to-pulse stability of the flashlamp-pumped laser source is smaller as pulses can spike and the pulse energy can vary.

The thickness of recast layers is measured with an image processing software in longitudinal sections. Recast layers of holes drilled with the Nd:YAG laser as well

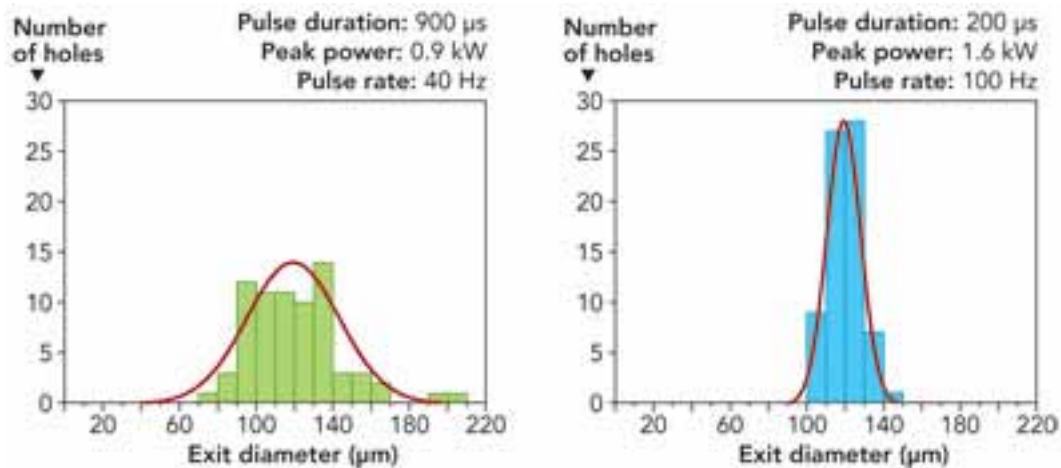

FIGURE 7. Distribution of exit diameters of holes drilled with the (left) flashlamp-pumped and (right) diode-pumped laser source.

as the fiber laser are comparable. The thickness of recast layers for both laser sources is approximately 20 µm.

Conclusion

Pulsed fiber lasers can provide a smaller beam parameter product at high mean powers compared to flashlamp-pumped Nd:YAG laser sources and are more economical as acquisition costs and operating costs are less. The specified hole geometry with a diameter of 120 μm and a depth of 5 mm in stainless steel 1.4301 can be achieved with a flashlamp as well as a diode-pumped laser source. When drilling with both laser systems, compromises between productivity and geometrical quality such as taper must be made. Parameters, which consider productivity as well as quality, are determined.

The productivity using a fiber laser is higher in the experiments compared to the Nd:YAG laser as the repetition rate of the Nd:YAG laser is smaller. The repetition rate cannot be raised because this increases taper and the standard deviation of hole diameters.

The tolerance of hole exit diameters is smaller when drilling with the fiber laser. This can be a result of the smaller times-diffraction-limit-factor M^2 as well as a better pulse-to-pulse stability of fiber lasers compared to flashlamp-pumped Nd:YAG lasers.

Drilling with flashlamp-pumped Nd:YAG lasers is still state-of-the-art. Nd:YAG lasers are commonly used for industrial applications such as drilling, cooling holes in turbine blades, or manufacturing holes in tool forms. There will be economic and technical benefits using a diode-pumped laser source for drilling if companies will change their laser sources from flashlamp-pumped Nd:YAG lasers to diode-pumped lasers such as fiber lasers in the future.

Reference

1. Poprawe R, Lasertechnik für die Fertigung Berlin Heidelberg, Springer Verlag, 2005, ISBN: 3-540-21406-2.

.....

JENS DIETRICH is group leader, laser drilling LLT, RWTH Aachen University and Akad. Oberrat. **INGOMAR KELBASSA** is vice and academic director LLT, RWTH Aachen University, and the department head RWTH LLT, Fraunhofer ILT, and chair for laser technology, RWTH Aachen University, Aachen, Germany.

Fiber laser spot welding

by Dr. KLAUS KRASTEL

FOR TODAY'S HIGH volume production in the automotive industry, resistance spot welding and laser remote welding, while well established, present advantages and disadvantages. For laser remote welding the main advantage is the significant cycle time reduction due to almost complete elimination of idle times and the mechanical advantages of laser welded seams. For resistance spot welding an advantage is the integrated clamping technology, which comes nearly for free. IPG Laser GmbH (www.ipgphotonics.com) has combined these advantages in a new technology, COSY, offering the resistance spot welding process, featuring the simplicity of clamping tools and production facilities, used in combination with the advantages of laser welding.

A problem for some types of solid-state laser welding is operator safety, which requires a protective housing for lasers with power up to 6 kW. When used for welding sheet metal in the automotive industry, safety equipment with fast reaction safety devices is necessary. This complicates their use in an open production facility, for example in automotive body and assembly plants.

Laser welding for the production of sheet metal components in body plants offers the following advantages:

- :: Higher process speed (shorter cycle times)
- :: Increased component strength by longer seams with higher torsional stiffness
- :: Efforts and costs comparable to today's modern resistance welding systems
- :: Realization of high job safety requirements with reduced costs

Fiber laser welding with a suitable welding tool provides the opportunity to accomplish all these objectives.

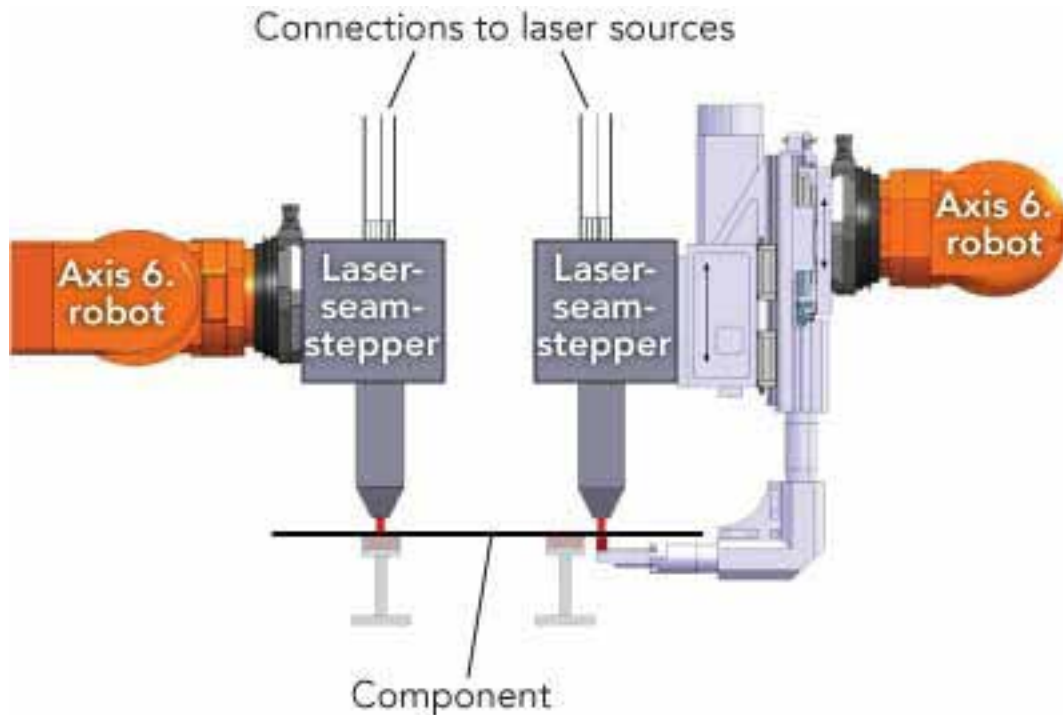

FIGURE 1. Laser-Seam-Stepper (left without C-Gun; right with C-Gun)

As shown in Figure 1, a Laser-Seam-Stepper (LSS1) module deflects the preset laser beam via a processing fiber into X-Y coordinates. For safety the laser beam is directed via funnel-shaped small angle housing. To release laser power, the housing has to contact the component to be welded.

Laser welding with or without a weaving function (± 1 mm) can be produced within the range determined by the housing (standard = 40 mm). The easiest application is a module mounted for example on the 6th axis of an industrial robot (30 kg handling capacity). The robot moves the module to the required welding position. In this position it is placed onto the component only by robot force. Below the component, within the range of the welding seams, a fixed lower tooling is used as counter force or support (as shown in Figure 1 on the left).

During a typical stepping operation (30 mm welding seam, 30 mm free space, 30 mm welding seam, etc.), a laser welding seam can be placed with a welding velocity of approximately 30 mm/s every 1.3 –1.5 seconds (see Figure 2).

The Laser-Seam-Stepper with C-Gun (LSS1C) is mounted on a servo motor driven traversing unit. This is similar to a resistance welding gun with compensating

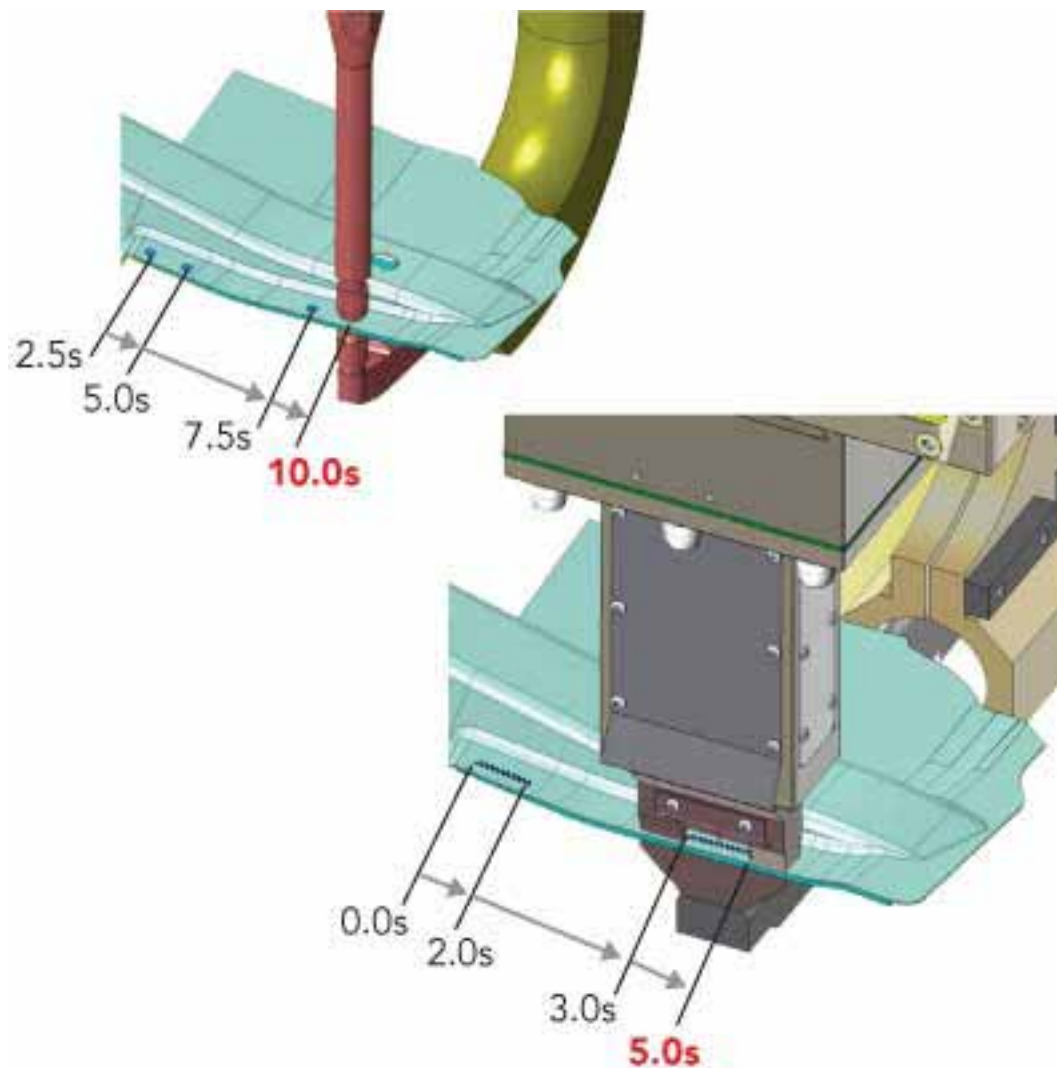

FIGURE 2. Resistance spot welding vs. laser welding with COSY LSS1-C-Gun

module (see Figure 1 right). This version allows an industrial robot (80 kg handling capacity) to move the LSS1C into a welding position and to close with a freely programmable force. The lower tool belonging to the C-gun is used as a counter force and additional safety equipment against unintended back reflected laser radiation.

The force-controlled closing of the laser welding system (0.5 – 3 kN) results in a fitting accuracy (gap < 0.2 mm) which is absolutely necessary for laser welding.

A module of the system compensates for tolerances regarding the position and geometry of the components. All joining forces (0.5 – 3 kN) applied in the system are performed within the laser welding tool only, the robot is not required for

these joining forces. During a typical stepping operation a laser seam can be placed every 1.7 – 2 seconds.

Features of the laser welding tools, COSY LSS1/LLS1C, with a compact IPG fiber laser are:

- :: The mechanically compact design of the basic unit COSY-LSS1 can be moved by an industrial robot with a handling capacity of 30 kg.
- :: The basic version enables the system to weld linear seams with a maximum length of 40 mm.
- :: Optionally a weaving function (3 – 30 Hz) can be switched on in order to spread the welding seam (2 mm).
- :: Laser sources are very compact fiber laser systems with power between 500 W and 3 kW and a total efficiency of more than 30 %.

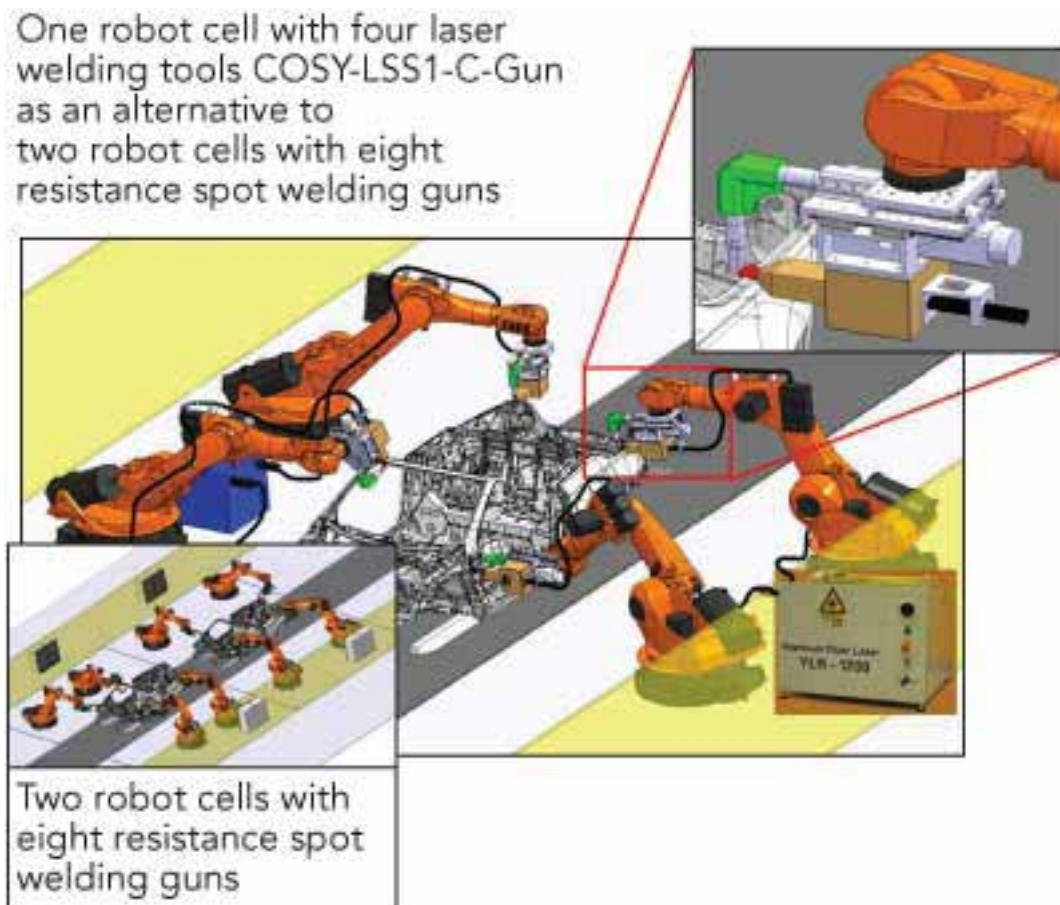

FIGURE 3. COSY LSS1-C-Gun with IPG fiber laser vs. resistance spot welding

Fiber laser spot welding

- :: The fiber laser and the welding head are maintenance free.
- :: The system is laser safe and can be used without complex laser protection housings. (Protective equipment as used in robot spot and arc welding cells is sufficient.)
- :: The LLS1C can join the sheet metal plates to be welded with a defined force in the area of the welding seam. This process reduces the normally high clamping effort during laser welding.
- :: The system is controlled via hardware interlock or buss systems. In the easiest case preconfigured seams of 10 mm – 40 mm seam length, including welding speed and laser power can be selected and started.

Typical applications for this system are sheet metal assemblies in the body-in-white production lines (see Figure 3), which up to now have been joined with many resistance welding spots. The intention of the COSY-LSS1 and COSY-LSS1-Gun is to replace two welding spots with a typical distance of approximately 30 mm by one laser step seam of approximately 30 mm.

For example in the case of 30 resistance spot welds the cycle time is approximately 75 seconds. If spot welding is replaced by laser welding in the manner described, only 15 laser weld seams are required. The cycle time can be reduced down to only 37 seconds in total, as well as the required floor space.

.....

Dr. KLAUS KRASTEL (kkrastel@ipgphotonics.com) is with IPG Laser GmbH
www.ipgphotonics.com.



Company Description:

IPG Photonics is the world leader in high-power fiber lasers & amplifiers. IPG manufactures active fiber lasers, direct diodes and amplifiers operating at 0.5–2 microns. Industrial lasers operating at 1 micron are available from 10 watts to >50 kilowatts for use in a wide range of applications such as materials processing, telecommunications, medical and other advanced applications. These devices feature low beam divergence, air cooling, high electrical efficiency, a compact, rugged package and unparalleled diode life.

www.IPGPhotonics.com

FROM THE INNOVATOR AND LEADING SUPPLIER OF FIBER LASERS FOR MANUFACTURING

Offering the most complete line of fiber lasers for all production applications

YLS

YLP

YLR

QCW

SYSTEMS

IPGP
NASDAQ
LISTED

HIGH POWER FIBER LASER SYSTEMS

The Choice of the Automotive, Aerospace and Metal Cutting Industries for Manufacturing.

- Featuring Output Power from 1000 to 50,000 Watts
- Continuous or Modulated Output
- Multi mode or Single mode
- High Electrical Efficiency
- LaserNet, Digital I/O and Analog Interfaces are Standard. DeviceNet, Profibus or Ethernet available upon request.

Q-SWITCHED (PULSED) FIBER LASERS

The Market Leader for Metal Marking Applications.

- Over 25 Models at 1070 nanometers, 8 models at 532 nanometers
- Pulse Energy > 10 milli joules
- Peak Power to 1 megawatt
- Pulse Duration from 70 picoseconds - 400 nanoseconds
- Air and Water Cooled Units
- Average Power up to 1 kW
- Rack mount or OEM Module Designs

RACKMOUNT CW FIBER LASERS

Ideally Suited for Medical Device Manufacturers, Research Labs, and Precise Cutting and Welding Applications.

- Models available from 20 to 1,000 Watts at 1070 nm, 10 to 100 Watts at 532 nm
- Multi Mode or Single Mode Delivery
- Air-Cooled to 500 Watts
- Modulation to 50 kilohertz
- Touchscreen, Digital, Analog, and RS-232 Standard Interface
- Internal Pulse Generator for 1070 nm models

QUASI - CW FIBER LASERS

The Replacement for Pulsed YAG Lasers, Including Aerospace Drilling.

- High Peak Power to 18 kW at 1070 nanometers
- Average CW Power to 1.8 kW
- Air-Cooled to 6 kW Peak
- Single Mode to 1.5 kW
- Internal Pulse Generator
- Full Industrial Interface

CUSTOM SYSTEMS & RETROFITS

Have IPG's Team of Laser Experts and Automation Engineers Design a Custom Turn-Key System or Retrofit an Existing CO₂ or YAG Laser System Utilizing IPG's Efficient and Economical Fiber Laser.

- Turn-key
- Multi-Axis
- Available with Auto-feed
- Class 1
- Optimized for Maximum Throughput
- Fully Integrated Fiber Laser



WWW.IPGPHOTONICS.COM

sales.us@ipgphotonics.com